

Riex NC70 Петля clip on, 45°, без пружины



Параметры

Brand	Riex
Тип крепежа	Screws on
Door Position	Накладная
Набор с монтажной планкой	No
Мягкое закрытие	No
Catalogue Page	2.16
Push for Open	Yes
Quantity in Box	200

Описание продукта

Riex NC70 Hinge Clip-On, 45° Upgrade your cabinetry with this cup angle hinge, designed specifically for doors with a 45° angle. It is perfect for various types of corner cabinets, offering practical features and reliable performance. Key Features: Easy Detachment: Push-button casted clip mechanism allows for quick and effortless detachment from the plate. Precise Adjustment: The hinge arm is equipped with a round sunk CAM screw offering a large adjustment range, making it easy to fine-tune the gap between the cabinet and the door. Steel Damper Option: Choose between hinges with a steel damper capable of absorbing even very dynamically closing doors for smooth, quiet operation or without a closing spring. 30° Angle Design: The door has a 45° angle to the normal hinge when closed, making it suitable for various types of corner cabinets. Standard Mounting: Can be installed using standard screws.

Аксессуары

Riex NC50/NC70 Заглушка для чашки петли
F000053



Компоненты

Riex NC50/NC70 Планка к петле clip on, H0, эксцентрик
F000043



Riex NC50/NC70 Планка к петле clip on, H0
F000046



Riex NC50/NC70 Планка к петле clip on, H0, эксцентрик+дюбели
F000050



Riex NC50/NC70 Планка к петле clip on, H2, эксцентрик
F000044



2D

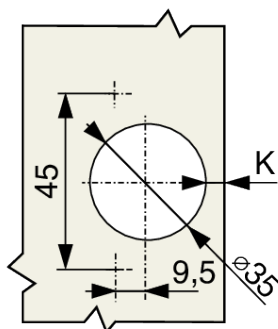
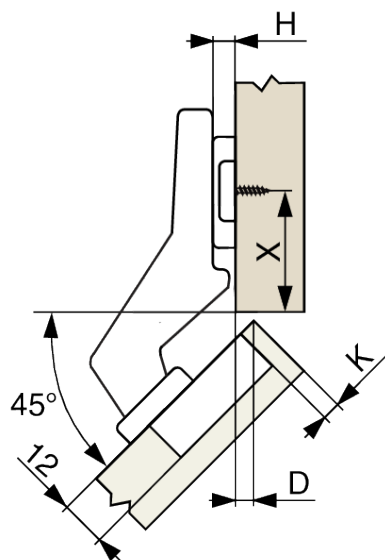

		H0	H2	H4
K	X	D	D	D
4	37	3	1	-1
5	36	4	2	0
6	35	5	3	1
7	34	6	4	2