

## Riex NU80 (16mm) Concealed slide, full extension, soft-close, synchro, 40 kg, 500 mm, 3D brackets



### Parámetros

Brand	Riex
Length	500 mm
Loading Capacity	40 kg
Mechanism	Soft-close
Synchronisation	Yes
Brackets	3D
Board Thickness	16 mm
Quantity in Box	10

### Descripción del producto

Riex NU80 Concealed Slide, Full Extension, Soft-Close, Synchro, 40 kg, 3D Brackets The Riex NU80 concealed drawer slides redefine performance and convenience for modern cabinetry. Featuring full extension, a soft-close mechanism, and advanced synchro technology, they deliver seamless functionality while enhancing the durability of your furniture. Key Features: Full-Extension Design: Provides complete access to the entire drawer. Soft-Close Mechanism: Ensures quiet, smooth closing with minimal effort. Synchro Technology: Offers perfectly aligned, synchronized movement for all slide segments. High Load Capacity: Handles up to 40 kg of total load, including drawer weight. 3D Adjustments: Enables 3D adjustments, including vertical, horizontal, and depth adjustments to ensure precise alignment. Upgrade your furniture with Riex NU80 slides, designed for precision, durability, and silent, smooth operation.

### Otras imágenes



### Accesorios

Riex Slides drilling template + Automatic punch  
F011442



## Dibujo en 2D

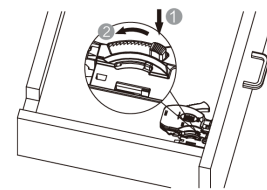
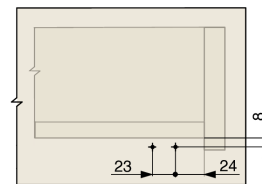
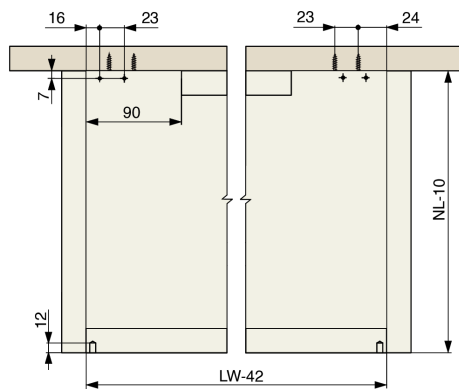
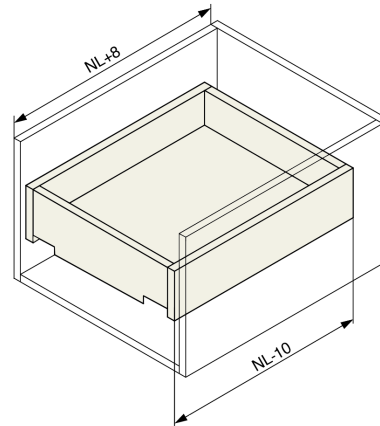
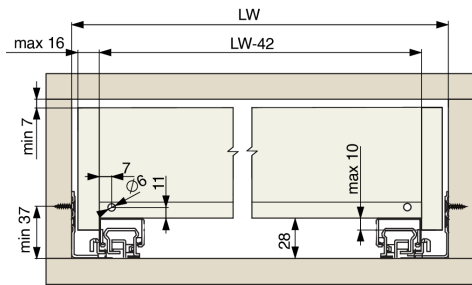

Height adjustment 0~+3mm

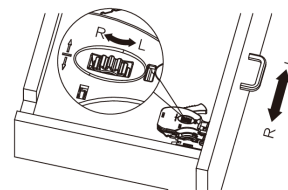

NL - 300/350

Side adjustment  $\pm 1.5$ mm

NL - 400/450/500

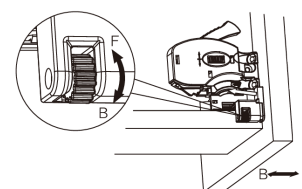

NL - 550/600

NL - 650

Depth (In and Out) adjustment 0 ~ +3mm

