

Riex NU80 (16mm) Concealed slide, full extension, soft-close, synchro, 40 kg, 350 mm, 3D brackets



Parámetros

Brand	Riex
Length	350 mm
Loading Capacity	40 kg
Mechanism	Soft-close
Synchronisation	Yes
Brackets	3D
Board Thickness	16 mm
Quantity in Box	10

Descripción del producto

Riex NU80 Concealed Slide, Full Extension, Soft-Close, Synchro, 40 kg, 3D Brackets The Riex NU80 concealed drawer slides redefine performance and convenience for modern cabinetry. Featuring full extension, a soft-close mechanism, and advanced synchro technology, they deliver seamless functionality while enhancing the durability of your furniture. Key Features: Full-Extension Design: Provides complete access to the entire drawer. Soft-Close Mechanism: Ensures quiet, smooth closing with minimal effort. Synchro Technology: Offers perfectly aligned, synchronized movement for all slide segments. High Load Capacity: Handles up to 40 kg of total load, including drawer weight. 3D Adjustments: Enables 3D adjustments, including vertical, horizontal, and depth adjustments to ensure precise alignment. Upgrade your furniture with Riex NU80 slides, designed for precision, durability, and silent, smooth operation.

Otras imágenes



Accesorios

Riex Slides drilling template + Automatic punch

F011442



Dibujo en 2D

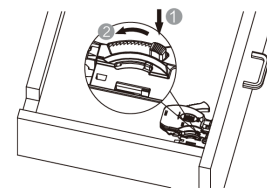
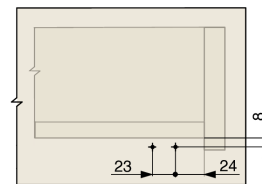
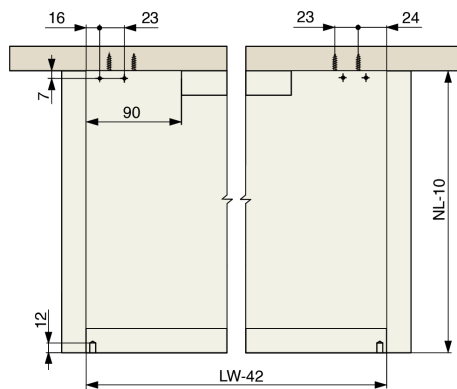
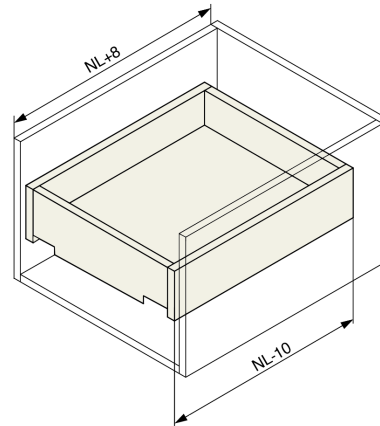
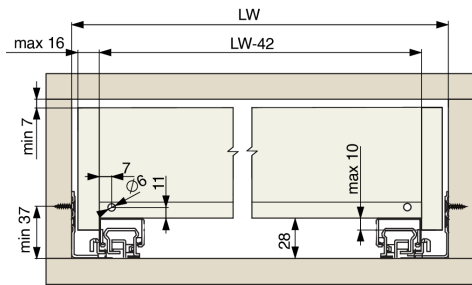

Height adjustment 0~+3mm

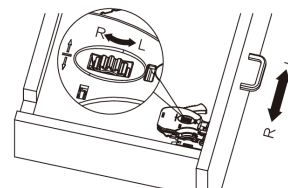

NL - 300/350

Side adjustment ± 1.5 mm

NL - 400/450/500

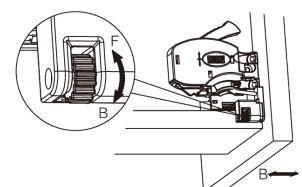

NL - 550/600

NL - 650

Depth (In and Out) adjustment 0 ~ +3mm

