

Riex NU70 Concealed slide, full extension, push for open, synchro, 35 kg, 450 mm, 2D brackets



Parámetros

Brand	Riex
Length	450 mm
Synchronisation	Yes
Loading Capacity	35 kg
Brackets	2D
Mechanism	Push for Open
Catalogue Page chapter 1 non CZ	1.49
Board Thickness	19 mm

Descripción del producto

Riex NU70 Concealed Slide, Full Extension, Push-to-Open, Synchro, 35 kg, 3D Brackets The Riex NU70 concealed drawer slides combine advanced push-to-open technology with synchro mechanisms for effortless operation in modern, handleless furniture designs. These slides ensure seamless functionality, aesthetic appeal, and precise adjustments for an exceptional user experience. Key Features: Full-Extension Slides: Ensure complete access to the drawer's contents. Push-to-Open Technology: Eliminating the need for handles. Smooth Operation: Synchro mechanism guarantees smooth, quiet operation of all slide segments. Loading Capacity: Withstands a total load capacity of 35 kg, including drawer weight. 3D Adjustments: Allows precise 3D adjustments of the drawer front, vertically (up and down), horizontally (left and right), and also gap between the front and cabinet can be adjusted. Adjustable Opening Force: Adjustable opening force using a convenient sliding lever. Upgrade your furniture with Riex NU70 slides, designed for optimal performance and a sleek, handle-free appearance. Perfect for high-end cabinetry and modern interiors.

Otras imágenes



Accesorios

Riex Slides drilling template + Automatic punch
F011442



Dibujo en 2D

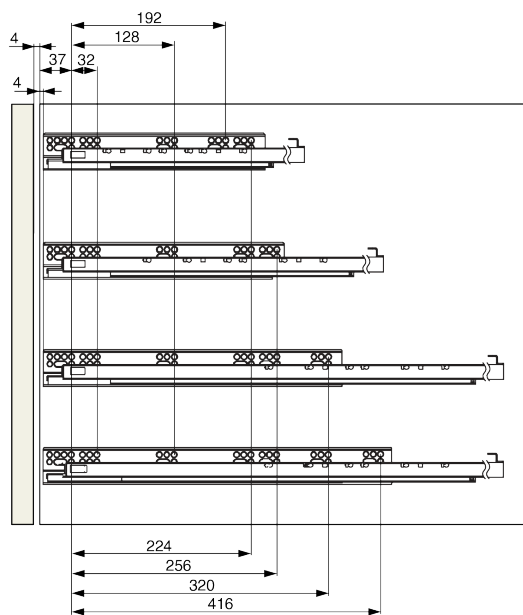
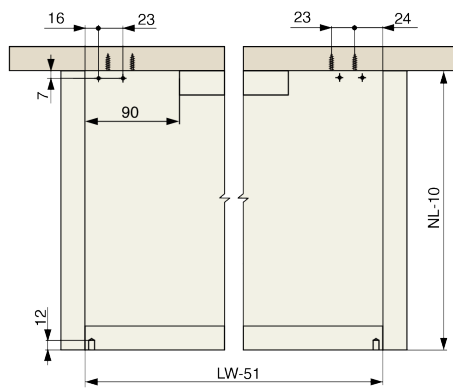
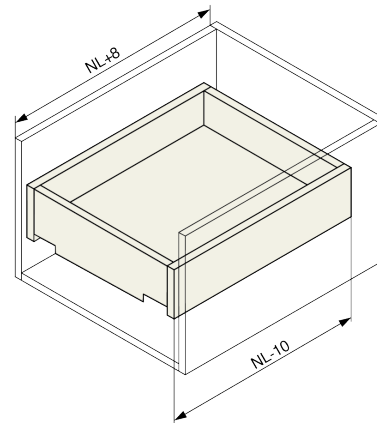
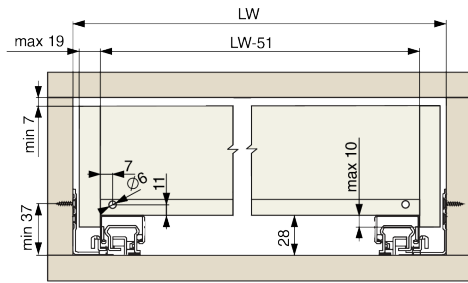

NL - 300/350

NL - 400/450/500

NL - 550/600

NL - 650