

RiexTrack Set mit 2 Erhöhungen gelocht, 650 mm, Dunkelgrau



Parameter

Marke	Riex
Farbe	Dunkelgrau
Länge	650 mm
Katalog Seite	1.10
Model	RiexTrack

Produktbeschreibung

Verlängerte Seitenwand mit Perforationen für RiexTrack-Schubladen. Zwischen diesen hochgezogenen Seitenwänden können Innenteiler eingesetzt werden, deren Position zwischen den Perforationen verändert werden kann.

Komponenten

RiexTrack Set mit 2 Vierkant Relings, 650 mm, Dunkelgrau
F000655



Anleitung

R|E|x

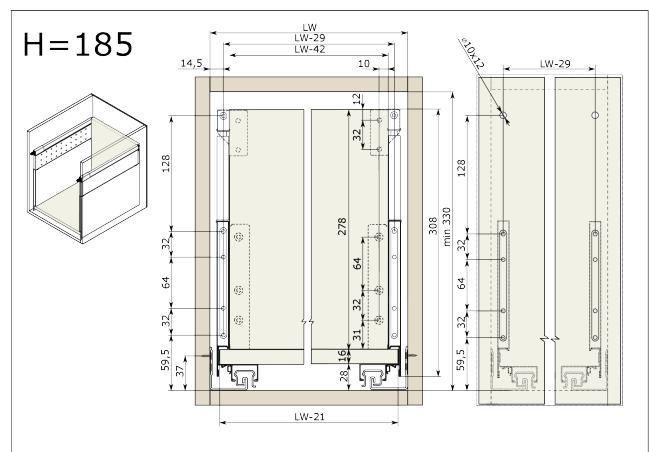
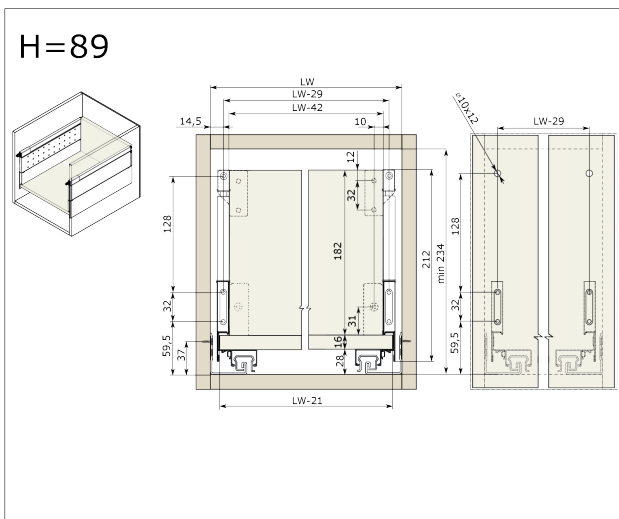
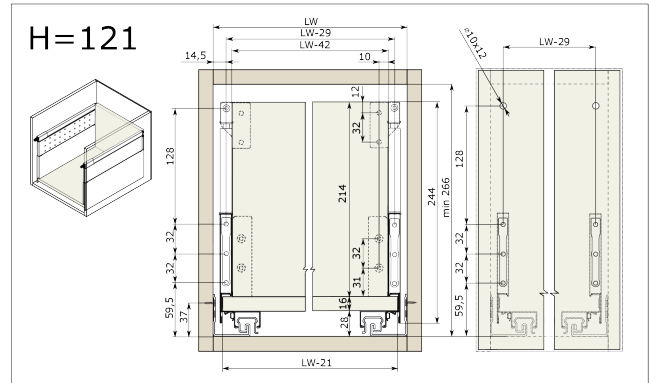
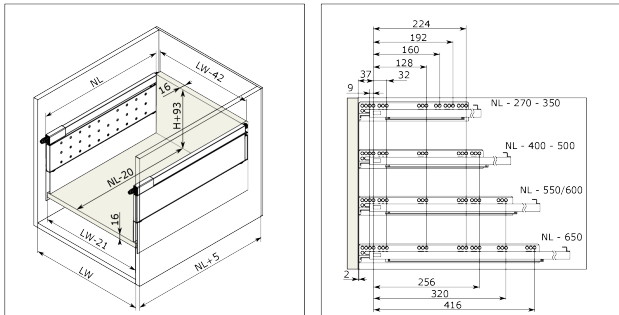

rev02

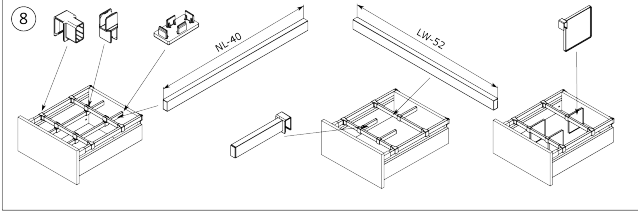
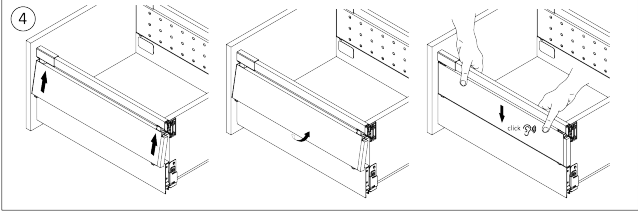
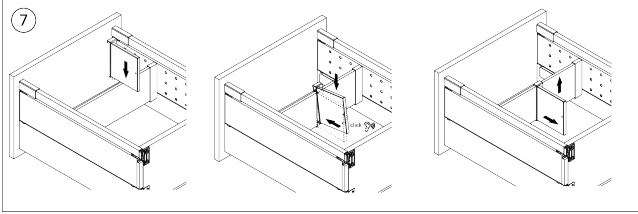
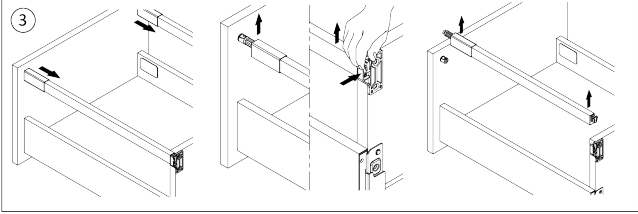
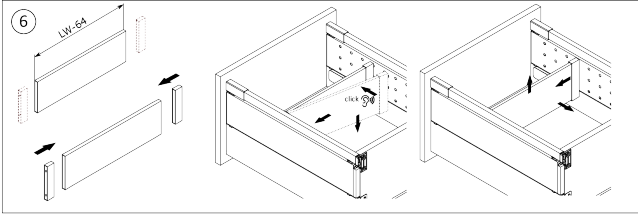
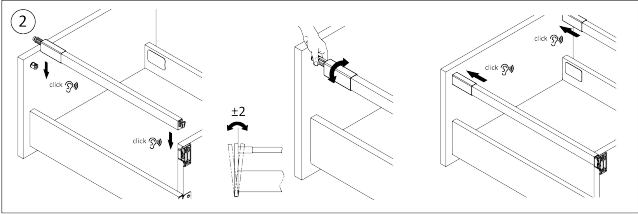
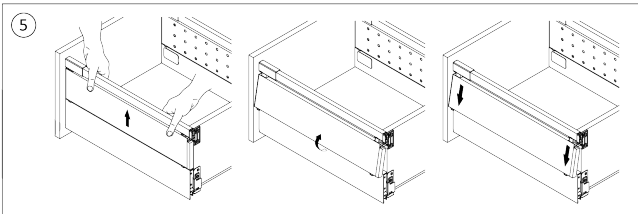
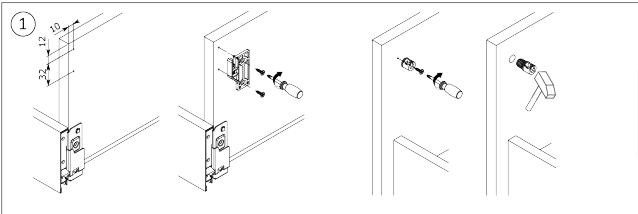

rev02

2D-Zeichnung

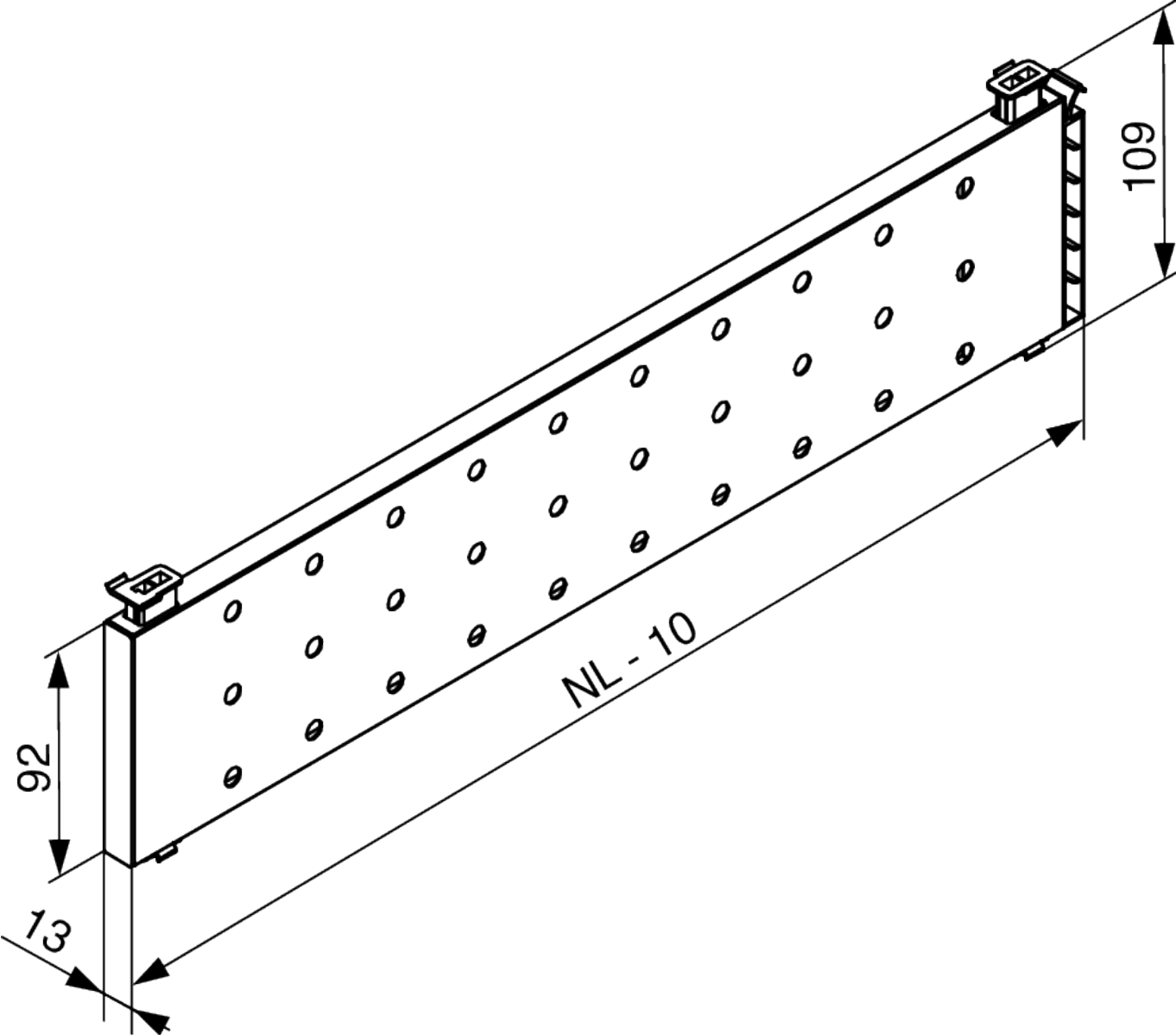

Reling

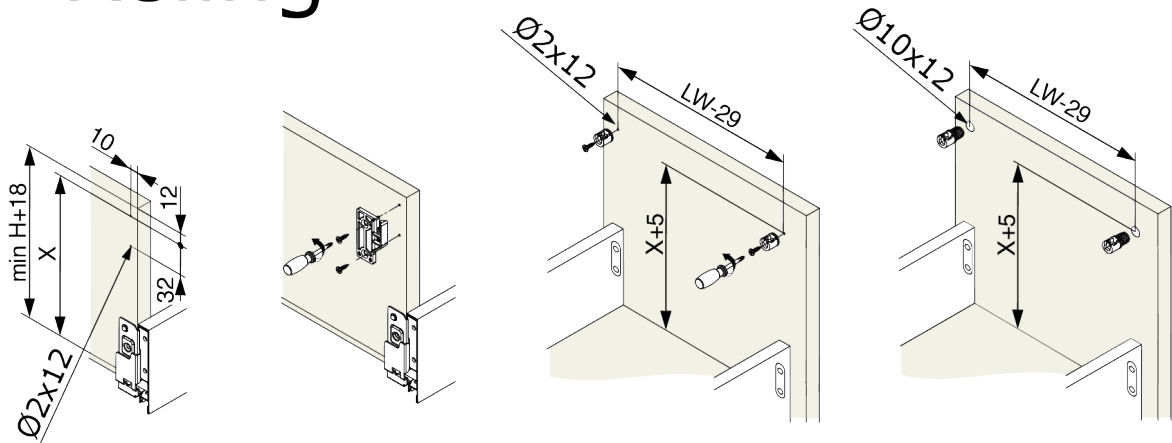

Zvýšená bočnice

