

Riex NX40 Set mit 2 Vierkant Relings und Rückwandbefestigung, 204/500, Weiß



Parameter

Marke	Riex
Farbe	Weiß
Länge	500 mm
Höhe	204 mm
Railingform	Platz
Model	NX40
Menge im Karton	25

Produktbeschreibung

Satz Längsseitenleisten zur Verstärkung der erhöhten Schubladenseiten. Inklusive Rückwandkonsolen, in die die Relling an der Rückseite einrastet. An der Vorderseite wird die Relling mit einem 10-mm-Dübel befestigt. Durch Drehen der Vorderseite der Relling kann die Länge angepasst werden.

Weitere Bilder



Zubehör

Riex NX40 Zubehör, Montageschablone für Relings

F000432



Anleitung

R|Ex

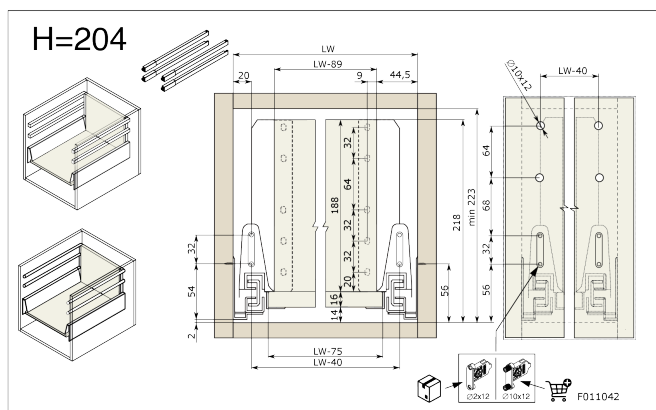
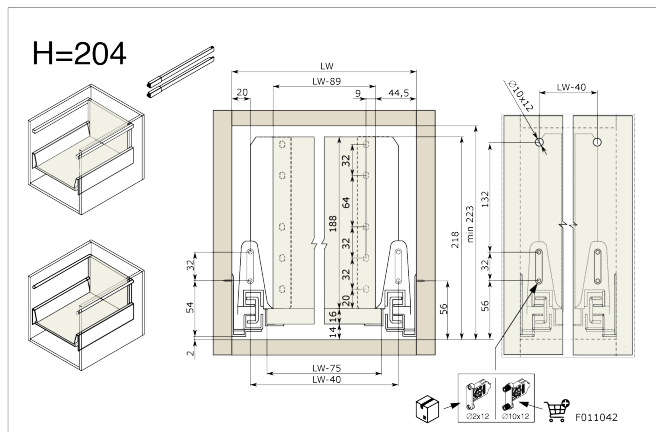
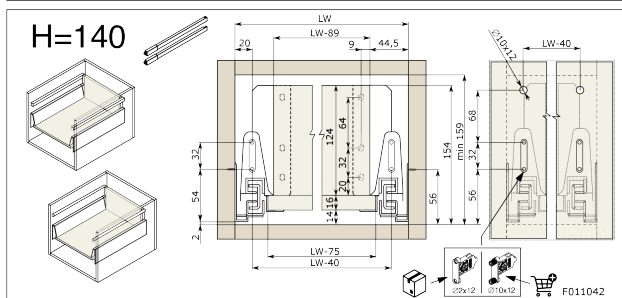
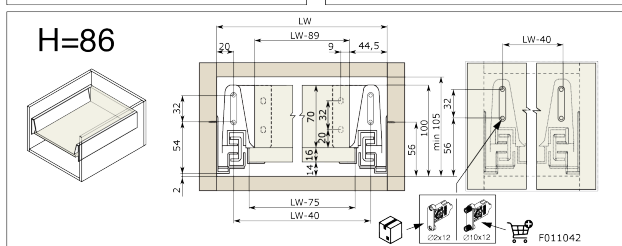
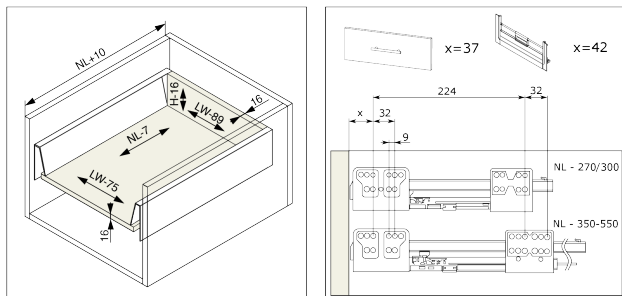

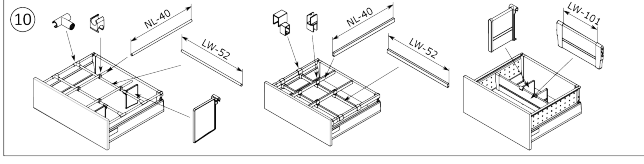
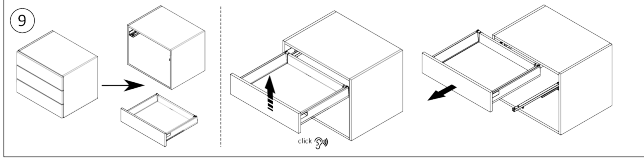
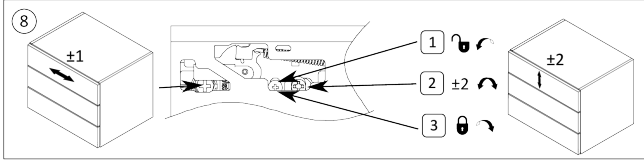
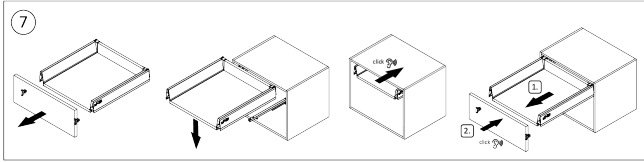
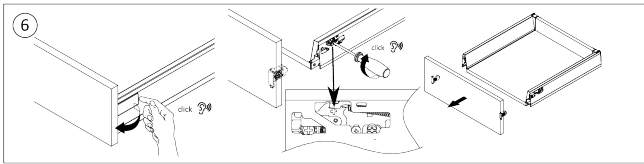
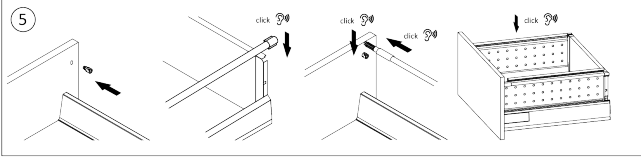
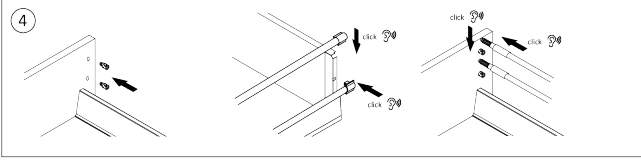
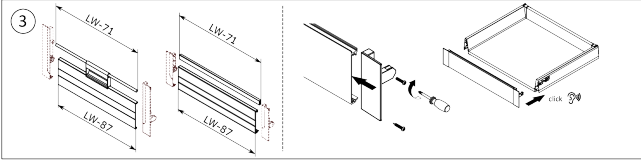
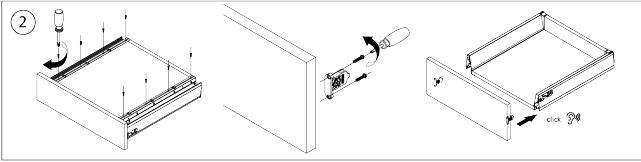
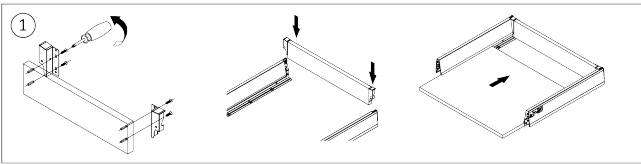

2D-Zeichnung

