

Riex NX40 Set mit 2 Rundstab Relings und Rückwandbefestigung, 204/400, Weiß

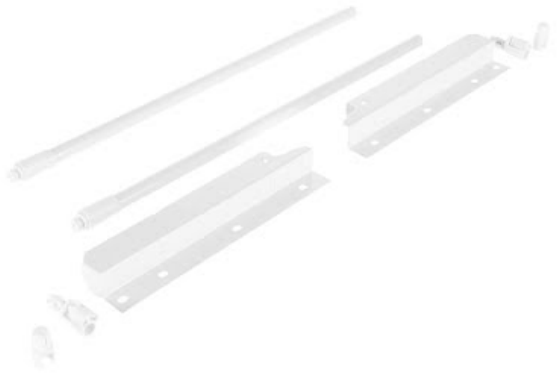

Parameter

Marke	Riex
Farbe	Weiß
Länge	400 mm
Höhe	204
Railingform	Rund
Model	NX40
Menge im Karton	25

Produktbeschreibung

Satz Längsseitenleisten zur Verstärkung der erhöhten Schubladenseiten. Inklusive Rückwandkonsolen, in die die Reling an der Rückseite einrastet. An der Vorderseite wird die Reling mit einem 10-mm-Dübel befestigt. Durch Drehen der Vorderseite der Reling kann die Länge angepasst werden.

Weitere Bilder



Zubehör

Riex NX40 Zubehör, Montageschablone für Relings

F000432



Komponenten

Riex NX40 Doppelwand Schubkasten, Basisschubkasten, 86/400 mm, Weiß

F000439



Anleitung

R|E|x

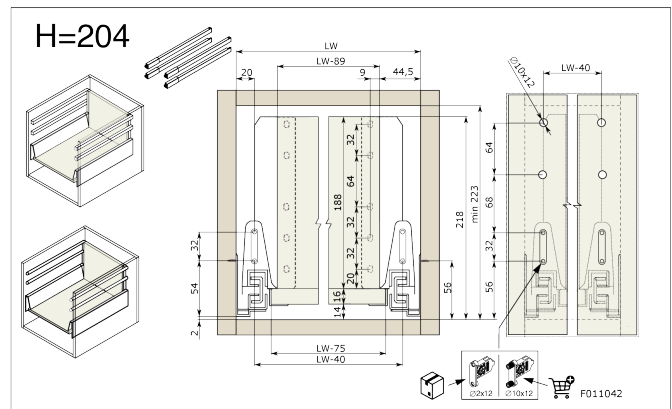
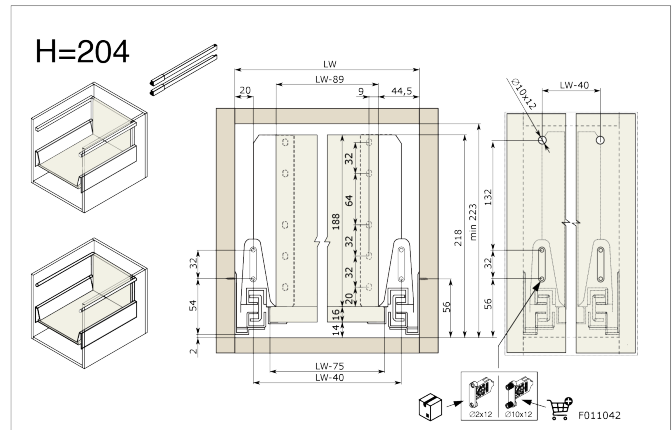
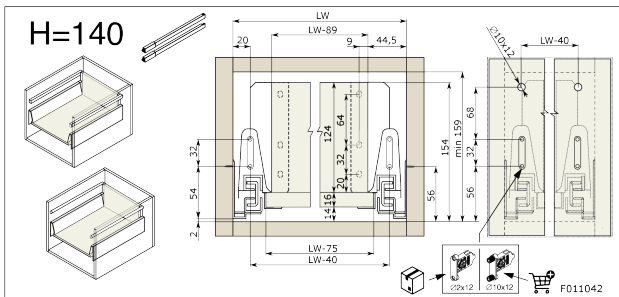
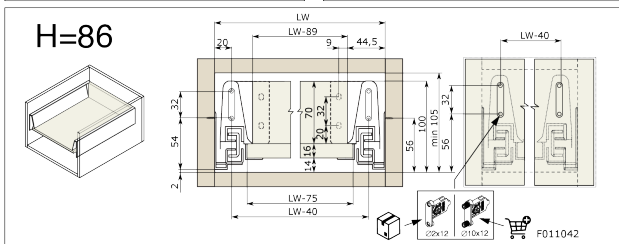
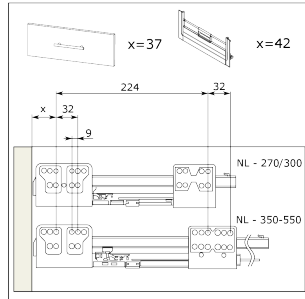
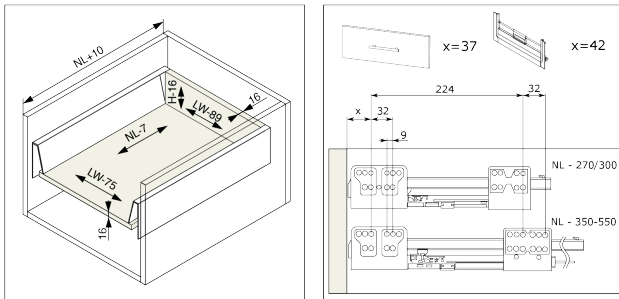

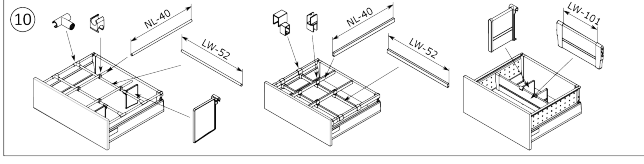
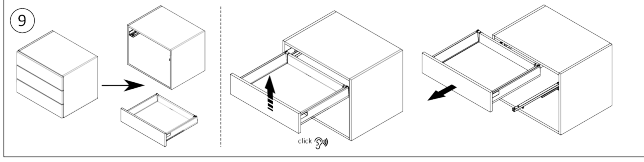
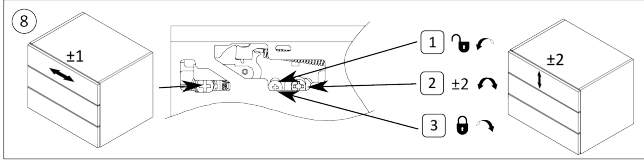
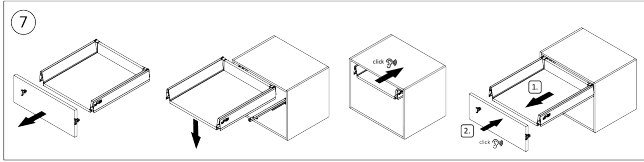
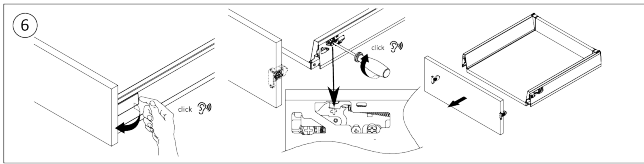
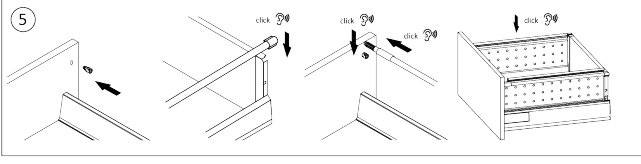
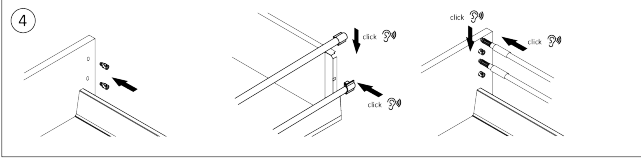
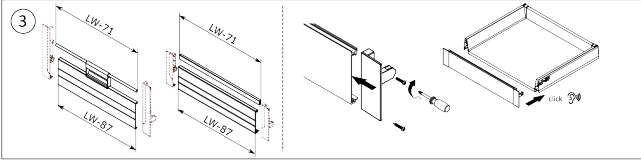
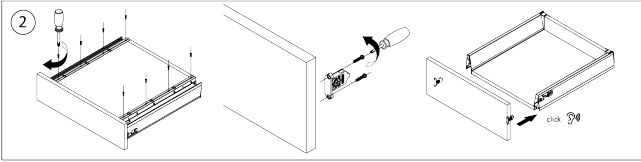
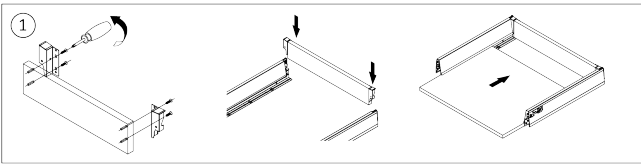

2D-Zeichnung

