

Riex NU80 Verdeckter Auszug, 16 mm, Vollauszug, Soft-Close, Synchro, 40 kg, 550 mm, 3D Halterung



Parameter

Marke	Riex
Länge	550 mm
Tragfähigkeit	40 kg
Mechanismus	Soft-Close
Synchronisation	Ja
Halterungen	3D
Plattenstärke	16 mm
Menge im Karton	10

Produktbeschreibung

Riex NU80 Concealed Slide, Full Extension, Soft-Close, Synchro, 40 kg, 3D Brackets The Riex NU80 concealed drawer slides redefine performance and convenience for modern cabinetry. Featuring full extension, a soft-close mechanism, and advanced synchro technology, they deliver seamless functionality while enhancing the durability of your furniture. Key Features: Full-Extension Design: Provides complete access to the entire drawer. Soft-Close Mechanism: Ensures quiet, smooth closing with minimal effort. Synchro Technology: Offers perfectly aligned, synchronized movement for all slide segments. High Load Capacity: Handles up to 40 kg of total load, including drawer weight. 3D Adjustments: Enables 3D adjustments, including vertical, horizontal, and depth adjustments to ensure precise alignment. Upgrade your furniture with Riex NU80 slides, designed for precision, durability, and silent, smooth operation.

Weitere Bilder



Zubehör

Riex Slides Bohrschablone + Stanze
F011442



2D-Zeichnung

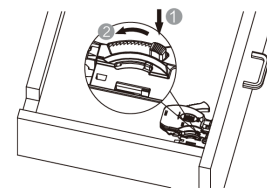
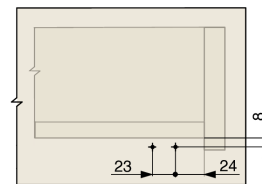
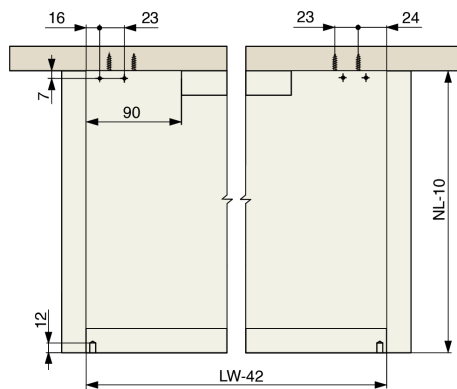
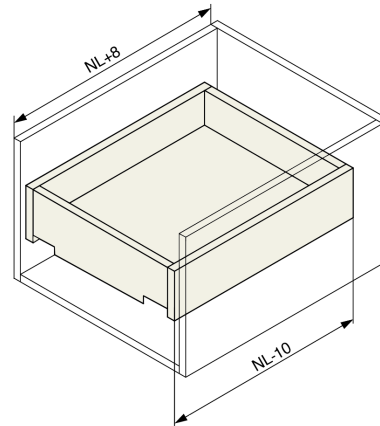
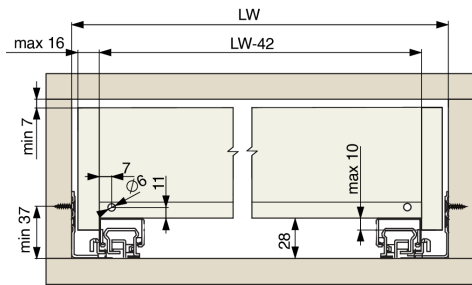

Height adjustment 0~+3mm

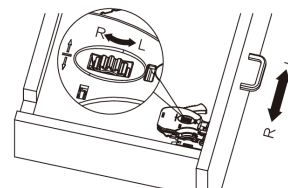

NL - 300/350

Side adjustment ± 1.5 mm

NL - 400/450/500

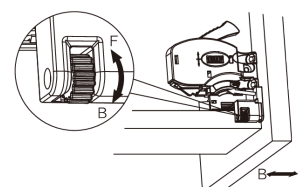

NL - 550/600

NL - 650

Depth (In and Out) adjustment 0 ~ +3mm

