

## Riex NU80 Verdeckter Auszug, 16 mm, Vollauszug, Soft-Close, Synchro, 40 kg, 500 mm, 3D Halterung



### Parameter

Marke	Riex
Länge	500 mm
Tragfähigkeit	40 kg
Mechanismus	Soft-Close
Synchronisation	Ja
Halterungen	3D
Plattenstärke	16 mm
Menge im Karton	10

### Produktbeschreibung

Riex NU80 Concealed Slide, Full Extension, Soft-Close, Synchro, 40 kg, 3D Brackets The Riex NU80 concealed drawer slides redefine performance and convenience for modern cabinetry. Featuring full extension, a soft-close mechanism, and advanced synchro technology, they deliver seamless functionality while enhancing the durability of your furniture. Key Features: Full-Extension Design: Provides complete access to the entire drawer. Soft-Close Mechanism: Ensures quiet, smooth closing with minimal effort. Synchro Technology: Offers perfectly aligned, synchronized movement for all slide segments. High Load Capacity: Handles up to 40 kg of total load, including drawer weight. 3D Adjustments: Enables 3D adjustments, including vertical, horizontal, and depth adjustments to ensure precise alignment. Upgrade your furniture with Riex NU80 slides, designed for precision, durability, and silent, smooth operation.

### Weitere Bilder



### Zubehör

Riex Slides Bohrschablone + Stanze  
F011442



## 2D-Zeichnung

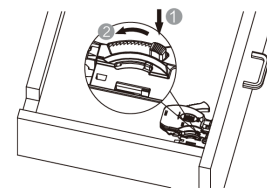
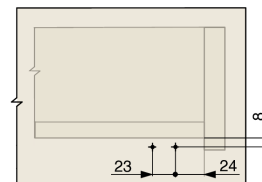
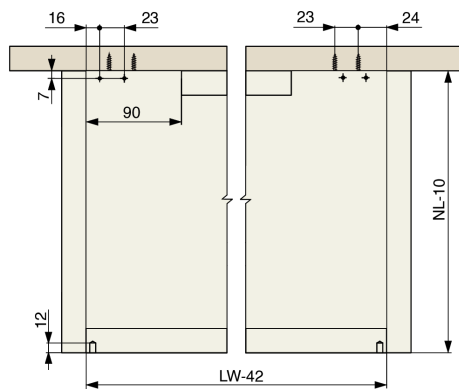
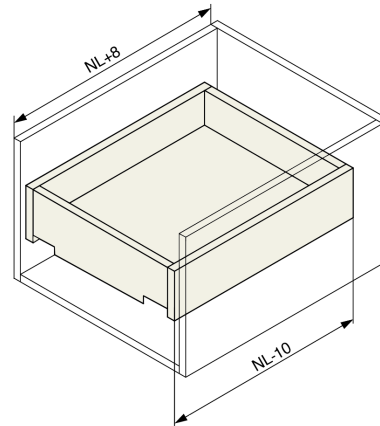
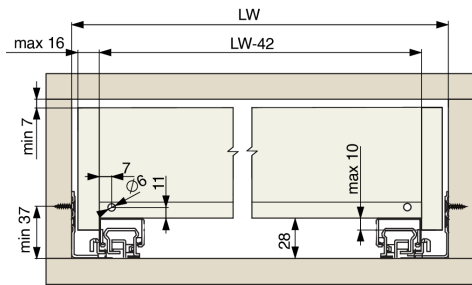

Height adjustment 0~+3mm

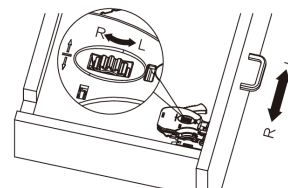

Side adjustment ± 1.5mm

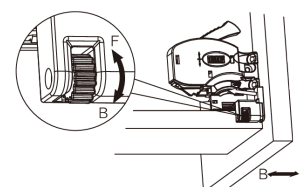

Depth (In and Out) adjustment 0 ~ +3mm

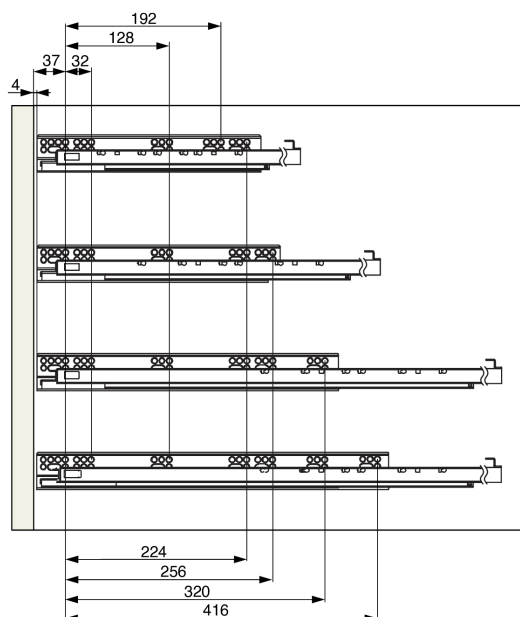

NL - 300/350

NL - 400/450/500

NL - 550/600

NL - 650