

## Riex ND30 Set mit 2 Rundstab Relings und Rückwandbefestigung, 201/300 mm, Weiß

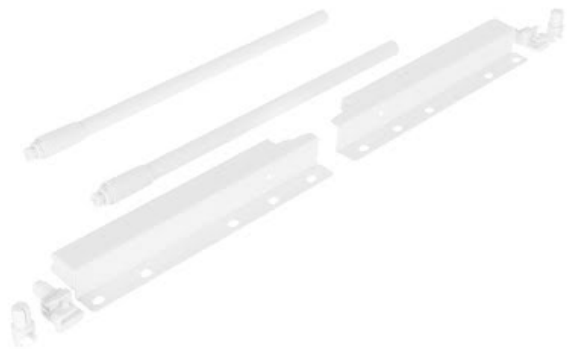

### Parameter

Marke	Riex
Farbe	Weiß
Länge	300 mm
Höhe	201 mm
Railingform	Rund
Model	ND30
Menge im Karton	20

### Produktbeschreibung

Riex ND30 Set of Longitudinal Railings with Back Brackets Upgrade your ND30 drawers with this versatile set of longitudinal railings designed for enhanced stability and customisation. Perfect for supporting raised drawer sides, these railings combine functionality with style. Key Features: Maximum Reinforcement: Includes 2 or 4 railings per set for maximum reinforcement. Adjustable Length: Adjustable length achieved by rotating the front of the railing. Secure Attachment: Secure attachment at the back with snap-in back panel brackets. Stable Mounting: Front mounted using a 10 mm dowel for added stability. Ensure a seamless and robust drawer system with these premium railings tailored for ND30 raised side configurations.

### Weitere Bilder



### Zubehör

Riex ND30 Montageschablone für Relings  
F004580



## Komponenten

---

**Riex ND30 Doppelwand Schubkasten, Basisschubkasten, 86/300 mm, Weiß**

F004581



## Anleitung

### R<sub>I</sub>Ex

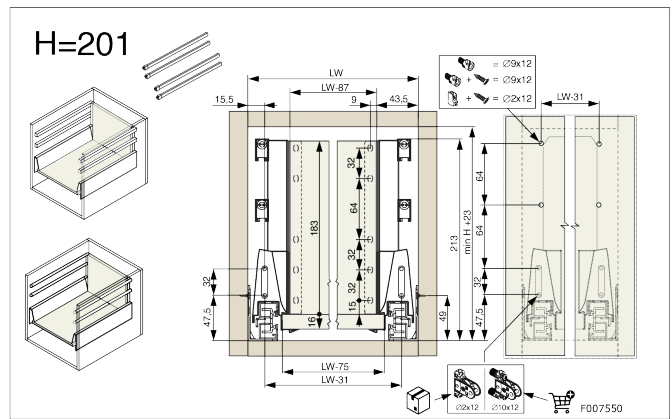
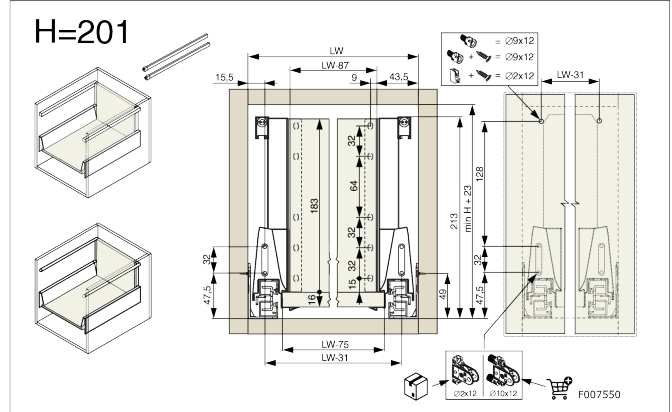
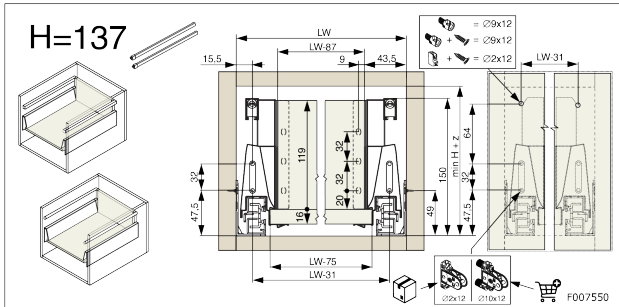
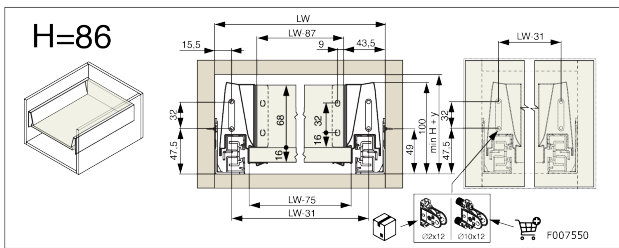
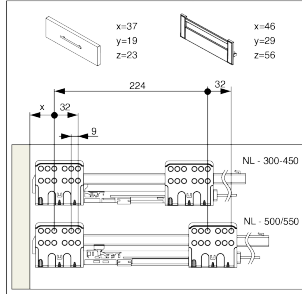
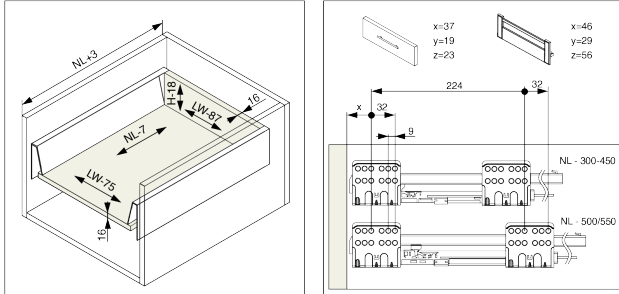

rev08

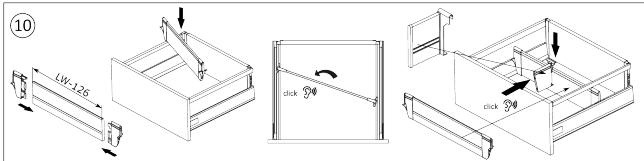
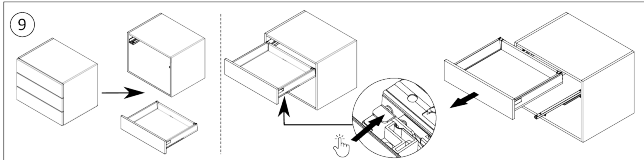
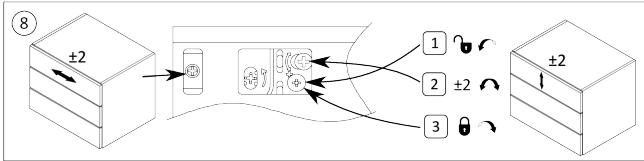
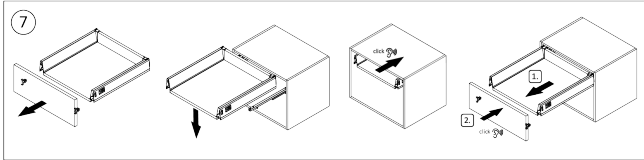
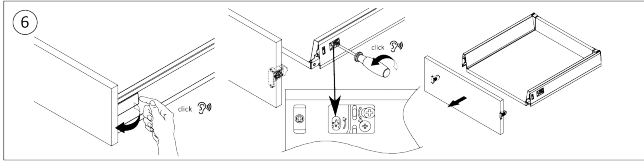
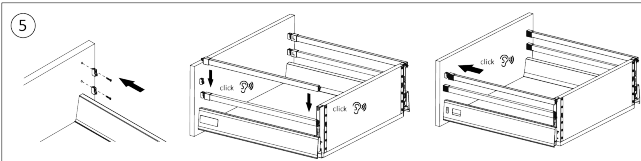
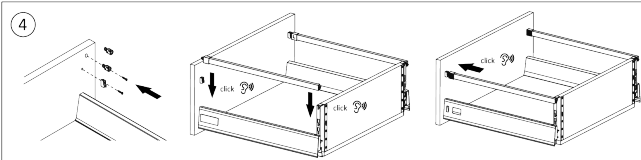
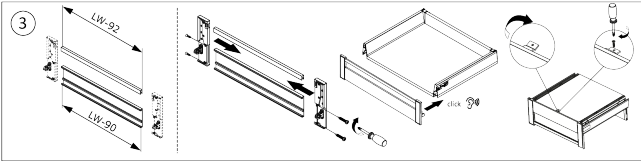
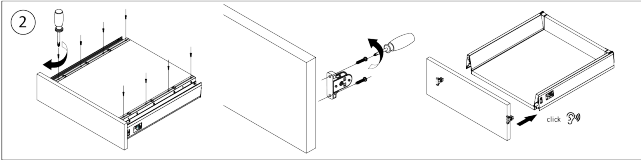
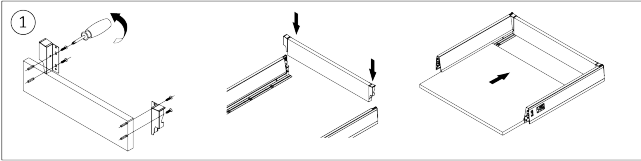

## 2D-Zeichnung

