

## Riex NB55 Kugelauszug, gestützt, Vollauszug, 45 kg/45 kg, H45, 1.2\*1.2\*1.5 mm, 500 mm



### Parameter

Marke	Riex
Länge	500 mm
Tragfähigkeit	45 kg
Mechanismus	Ohne Mechanismus
Höhe	45 mm
Schienenstärke	1,2*1,2*1,5 mm
Menge im Karton	15

### Produktbeschreibung

Riex NB55 Ball Bearing Slide, Full Extension, 45 kg, H45 Enhance your furniture with the Riex NB55 ball-bearing slides, designed for reliable and smooth drawer operation. These slides are perfect for all-wood drawers, offering both supported and non-supported versions for a tailored fit to your needs. The Riex NB55 slides feature a robust construction with material thicknesses of 1.2 x 1.2 x 1.5 mm, ensuring durability. With a full-extension design, you'll have complete access to the drawer's contents. Additionally, a built-in rubber stop secures the drawer in the closed position for enhanced functionality and safety. Key Features: Versatile Configurations: Available in supported and non-supported versions. Full-Extension Design: Provides full access to drawer contents. Sturdy Construction: Built with thicknesses of 1.2 x 1.2 x 1.5 mm for durability. Rubber Stop: Ensures secure drawer closure. High Load Capacity: Handles weights from 23 kg to 45 kg, depending on length. Transform your drawers with the Riex NB55 slides, combining superior engineering with exceptional reliability to meet a variety of furniture requirements.

### Zubehör

#### Riex Slides Bohrschablone + Stanze

F011442



## 2D-Zeichnung

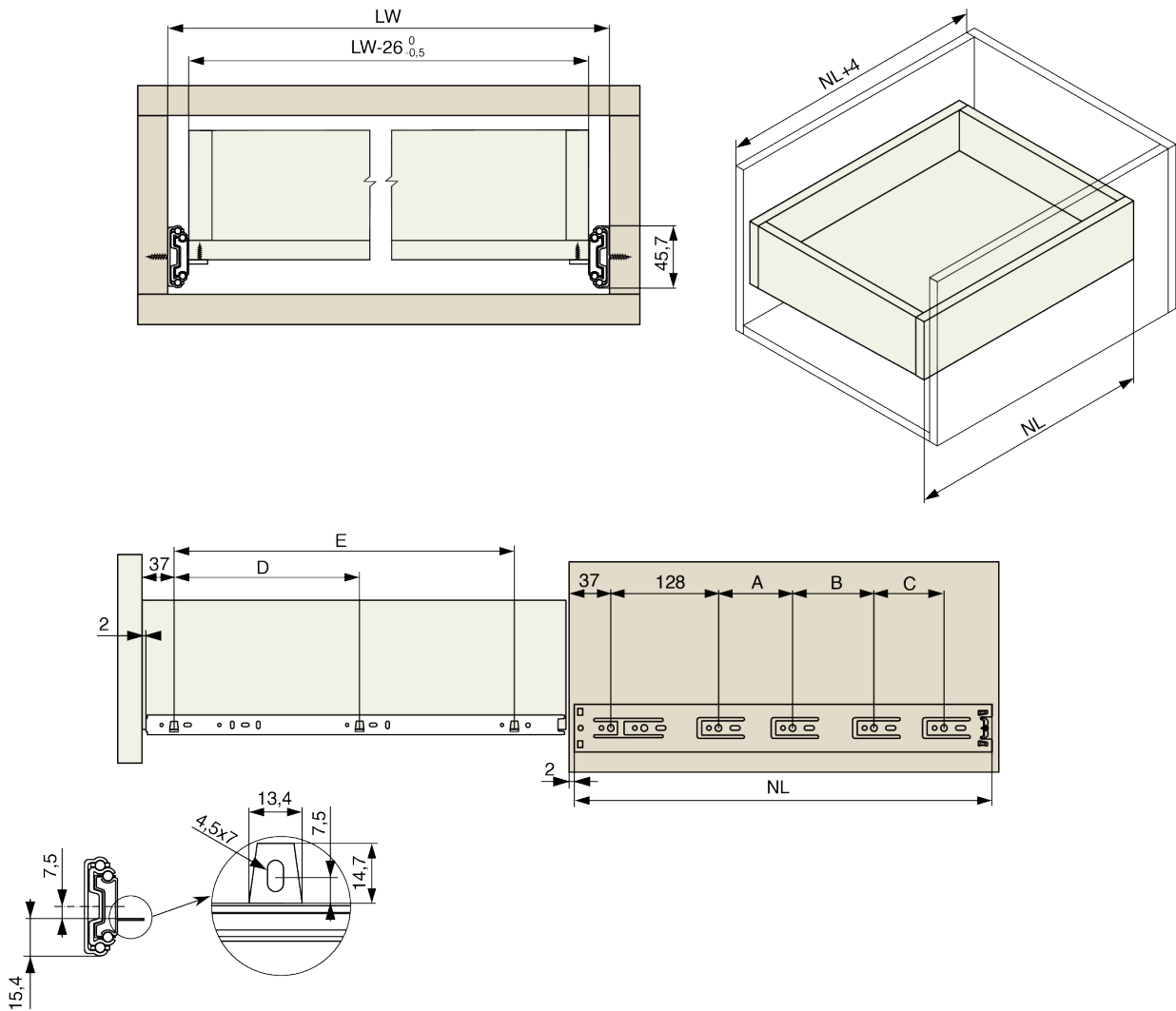

NL [mm]	A [mm]	B [mm]	C [mm]	D [mm]	E [mm]
300	96	-	-	-	192
350	96	-	-	-	192
400	96	96	-	192	320
450	96	128	-	192	356
500	96	128	64	192	416
550	96	128	96	192	448
600	96	128	128	192	480