

## Kesse DISPENSA, Tablar ARENA pure, W450, Anthrazit



### Parameter

Farbe	Anthrazit
Marke	Kesseböhmer (Kesseboehmer)
Katalog Seite	10.15
Korpusbreite	450 mm
Korbart	ARENA pure
Hersteller Produktbezeichnung	236469 9846

### Produktbeschreibung

Kesse DISPENSA Baskets Upgrade your kitchen storage with versatile DISPENSA baskets, engineered for maximum utility and aesthetics. These baskets are available in multiple elegant finishes and sizes. They seamlessly integrate into the DISPENSA family, offering a practical solution for various organizational needs. For added flexibility, a single DISPENSA basket can be replaced with two COMFORT II baskets, ensuring customization to suit your preferences. Designed with premium quality, these baskets enhance accessibility and visual appeal in any kitchen. Key Features: Flexible design allows one basket to be replaced by two COMFORT II baskets. Fully compatible with the DISPENSA system and Youboxx sets for extended functionality. Frame sold separately for complete system integration. Designed by Kesseböhmer for top-notch durability and innovative storage solutions.

### Zubehör

**Kesse DISPENSA, Rahmen, H900-1300, Anthrazit**  
F005302



**Kesse DISPENSA, Fronthalter Set, W450, Anthrazit**  
F005331



### Komponenten

**Kesse DISPENSA, Rahmen, H1900-2300, Anthrazit**  
F005310



**Kesse DISPENSA, Rahmen, H1200-1600, Anthrazit**  
F005304



**Kesse DISPENSA, Rahmen, H1600-2000, Anthrazit**  
F005306



**Kesse DISPENSA, Rahmen, H1800-2200, Anthrazit**  
F005308



## Anleitung

### Montageanleitung ARENA-Einhängetablar Mounting instructions ARENA-clip-on shelf Instructions d'assemblage ARENA-tableau

#### A. Montage Mounting Assemblage

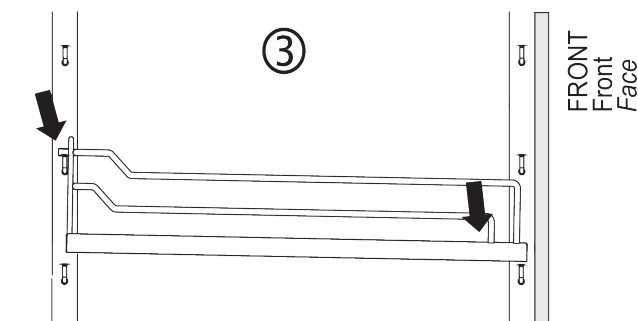
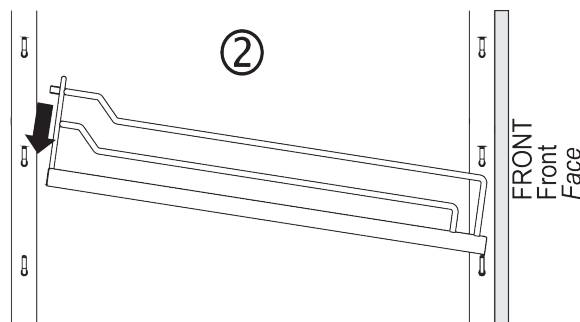
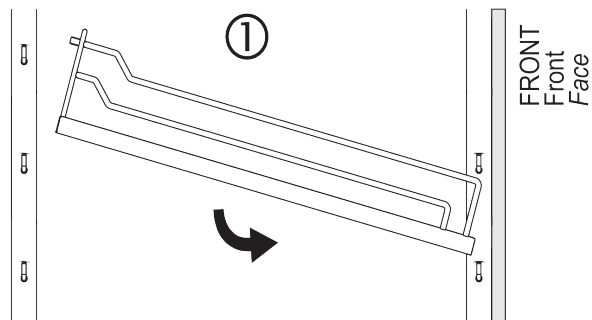

bei der Tablar montage  
nur mittig auf Holzplatte  
und im hinteren Bereich der Reling drücken

onDuring assembling the shelves,  
please do only push  
in the middle of the panel  
and only in the rail in the back

Lors du montage du tableau,  
poussez le centre du plateau bois  
et la partie derrière de la galerie.

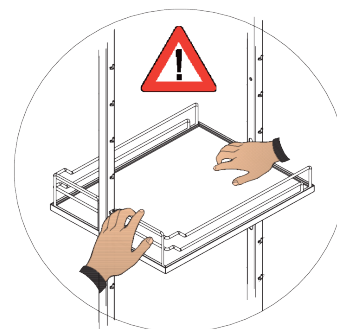

**B. Demontage**  
Dismounting  
Démontage

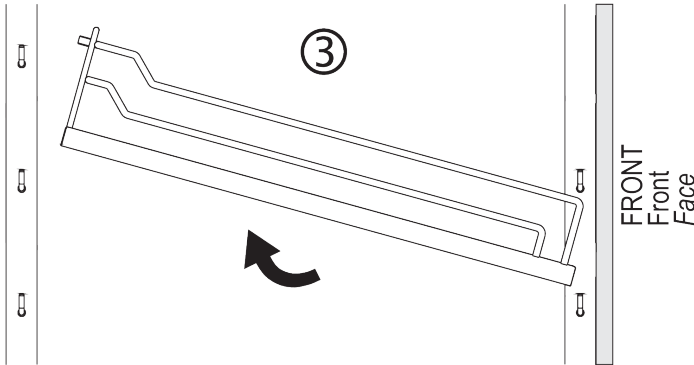
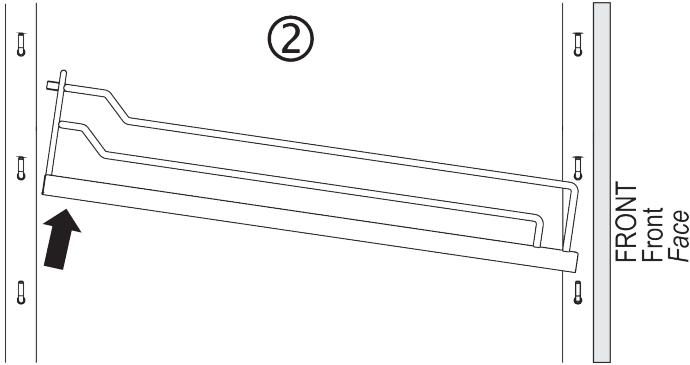
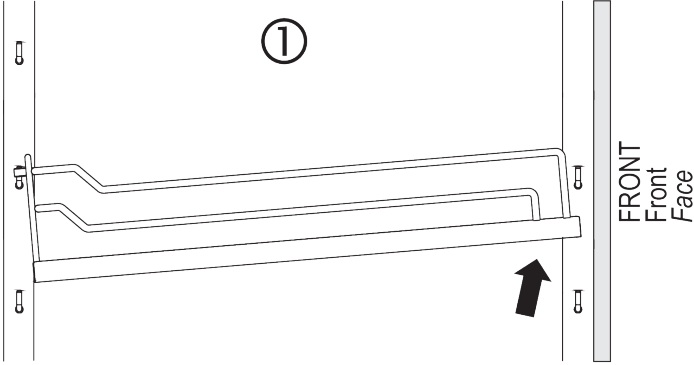

## 2D-Zeichnung

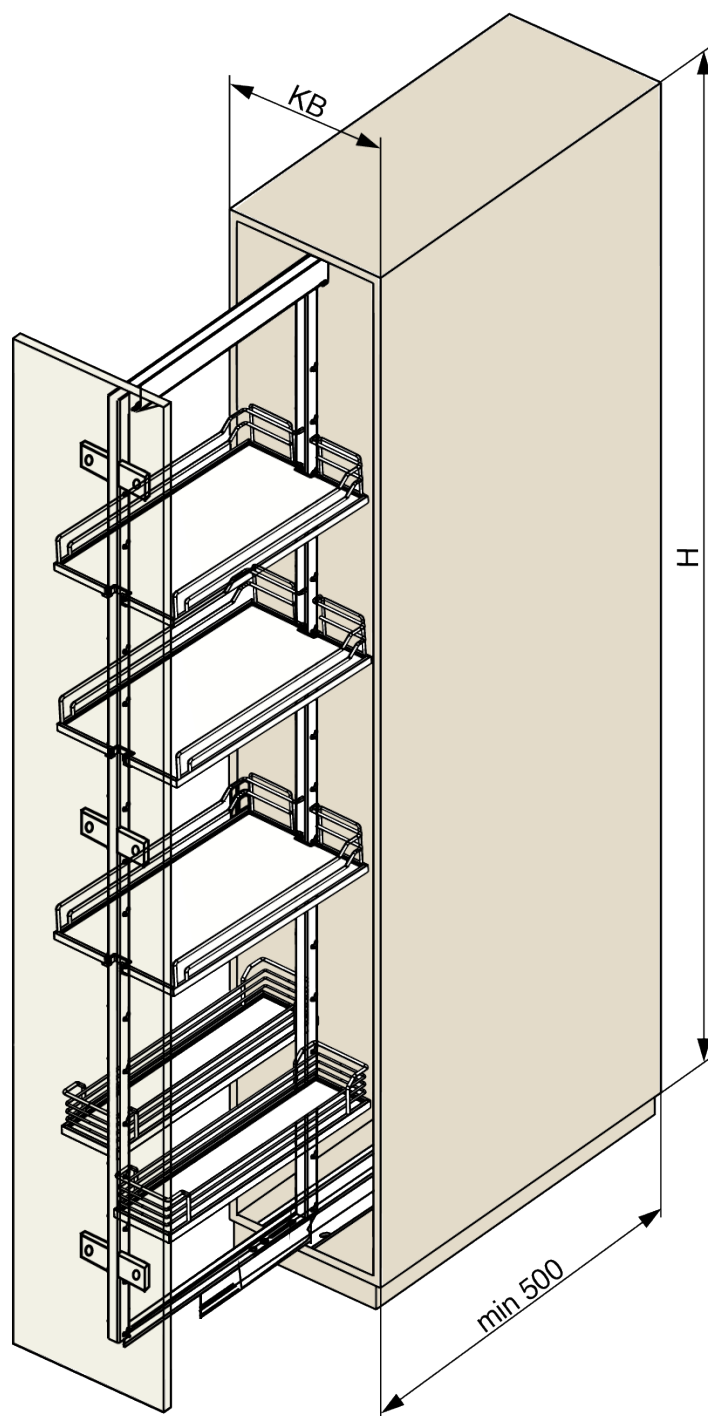

KB
150
200
250
300
400
450
500
600

H
900-1300
1200-1600
1600-2000
1800-2200
1900-2300